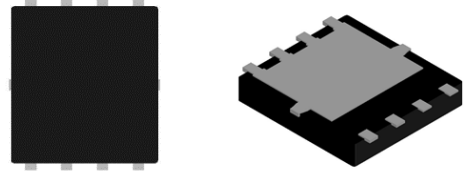

**FEATURES**

- Drain-Source Withstand Voltage: 100V
- Max.  $R_{DS(on)}$  :  $19m\Omega @ V_{GS}=10V$   
 $28m\Omega @ V_{GS}=4.5V$
- Automotive applications
- AEC-Q101 Qualified
- Excellent ON resistance
- General footprint package PDFN5×6-8L
- 100% Rg and Avalanche tested
- MSL1

**PRODUCT APPEARANCE**

PDFN5×6-8L

**DESCRIPTION**

The SND1019DNAQ is N-Channel enhancement MOS Field Effect Transistor. Uses advanced trench technology and design to provide excellent  $R_{DS(ON)}$  with low gate charge. This device is suitable for use in high performance automotive DC-DC conversion, power switch and charging circuit. Standard Product SND1019DNAQ is in compliance with RoHS.

**Applications:**

- Automotive systems
- DC/DC converters
- Power supply converters circuit
- Load/Power Switching for portable device

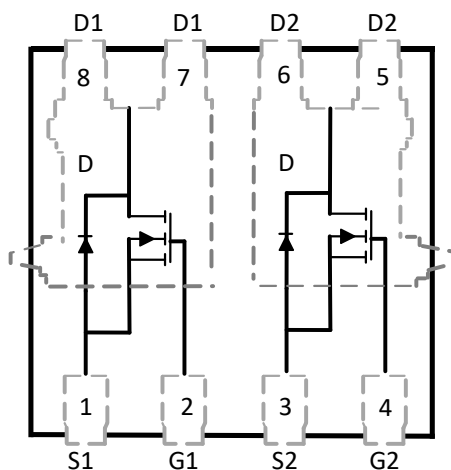
**PIN CONFIGURATION**

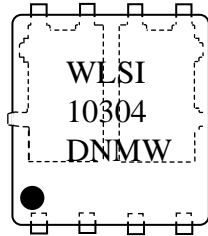
**MARKING**

WLSI = Company (Group) Code  
 10304 = Device Code  
 DN = Special Code  
 M = Month  
 W = Week

**LIMITING VALUES**

Parameter	Symbol	Condition	Value	Unit
Drain-Source Voltage	$V_{DS}$		100	V
Gate-Source Voltage	$V_{GS}$		+20/-16	V
Continuous Drain Current	$I_D$	$T_C=25^{\circ}C$	46	A
		$T_C=100^{\circ}C$	33	A
Pulsed Drain Current <sup>(3)</sup>	$I_{DM}$		83	A
Continuous Drain Current	$I_D$	$T_A=25^{\circ}C$	8	A
		$T_A=100^{\circ}C$	6	A
Avalanche Energy $L=0.3mH$	$E_{AS}$		44	mJ
Power Dissipation <sup>(3)</sup>	$P_D$	$T_C=25^{\circ}C$	89	W
		$T_C=100^{\circ}C$	45	W
Power Dissipation <sup>(1)</sup>	$P_D$	$T_A=25^{\circ}C$	2.6	W
		$T_A=100^{\circ}C$	1.3	W
Operating Junction Temperature	$T_J$		-55 to 175	$^{\circ}C$
Storage Temperature Range	$T_{STG}$		-55 to 175	$^{\circ}C$

**THERMAL RESISTANCE RATINGS**

Single Operation					
Parameter		Symbol	Typical	Maximum	Unit
Junction-to-Ambient Thermal Resistance <sup>(1)</sup>	Steady State	$R_{\theta JA}$	48	58	°C/W
Junction-to-Case Thermal Resistance <sup>(2)</sup>	Steady State	$R_{\theta JC}$	1.2	1.7	

**ELECTRONICS CHARACTERISTICS**

Parameter	Symbol	Conditions	Min	Typ	Max	Unit
<b>OFF CHARACTERISTICS</b>						
Drain-to-Source Breakdown Voltage	$BV_{DSS}$	$V_{GS}=0V$ , $I_D = 250\mu A$	100			V
Drain-to-Source Breakdown Voltage Temperature Coefficient	$BV_{DSS}/T_J$			50		mV/°C
Zero Gate Voltage Drain Current	$I_{DSS}$	$V_{DS}=100V$ , $V_{GS}=0V$ , $T_J=25^\circ C$			10	$\mu A$
		$V_{DS}=100V$ , $V_{GS}=0V$ , $T_J=125^\circ C$			250	$\mu A$
Gate-to-source Leakage Current	$I_{GSS}$	$V_{DS}=0V$ , $V_{GS}=20V$			100	nA
<b>ON CHARACTERISTICS</b>						
Gate Threshold Voltage	$V_{GS(TH)}$	$V_{GS}=V_{DS}$ , $I_D = 250\mu A$	1.6	2.0	2.4	V
Threshold Temperature Coefficient	$V_{GS(TH)}/T_J$			-5.1		mV/°C
Drain-to-source On-resistance <sup>(4)</sup>	$R_{DS(on)}$	$V_{GS} = 10V$ , $I_D = 15A$		14.5	19	m $\Omega$
		$V_{GS} = 4.5V$ , $I_D = 15A$		20.5	28	
<b>CHARGES, CAPACITANCES AND GATE RESISTANCE</b>						
Input Capacitance	$C_{ISS}$	$V_{GS} = 0V$ , $f = 1.0MHz$ , $V_{DS}=25V$		960		pF
Output Capacitance	$C_{OSS}$			538		
Reverse Transfer Capacitance	$C_{RSS}$			65		
Total Gate Charge <sup>(5)</sup>	$Q_{G(TOT)}$	$V_{GS}=10V$ , $V_{DS}=80V$ , $I_D = 15A$		20		nC
Total Gate Charge <sup>(5)</sup>	$Q_{G(TOT)}$	$V_{GS}=4.5V$ , $V_{DS}=80V$ , $I_D = 15A$		11		

Parameter	Symbol	Conditions	Min	Typ	Max	Unit
Gate-to-Source Charge <sup>(5)</sup>	$Q_{GS}$	$V_{GS}=10V,$ $V_{DS}=80V, I_D=15A$		3.0		
Gate-to-Drain Charge <sup>(5)</sup>	$Q_{GD}$			6.3		
Gate Resistance	$R_g$	$f=1MHz$		0.9		$\Omega$
<b>SWITCHING CHARACTERISTICS <sup>(5)</sup></b>						
Turn-On Delay Time	$t_{d(ON)}$	$V_{GS}=5V,$ $V_{DS}=80V,$ $I_D=15A, R_G=5\Omega$		7.6		ns
Rise Time	$t_r$			21.8		
Turn-Off Delay Time	$t_{d(OFF)}$			16.0		
Fall Time	$t_f$			22.2		
Body Diode Reverse Recovery Time	$t_{rr}$	$I_F=15A,$ $dI/dt=100A/\mu s$		40.4		ns
Body Diode Reverse Recovery Charge	$Q_{rr}$	$I_F=15A,$ $dI/dt=100A/\mu s$		41		nC
<b>BODY DIODE CHARACTERISTICS</b>						
Forward Voltage <sup>(4)</sup>	$V_{SD}$	$V_{GS}=0V, I_S=15A$	0.5	0.8	1.2	V

( $T_J=25^\circ C$ , unless otherwise noted.)

**Note:**

- (1) FR-4 board (38mm×38mm×t1.6mm, 70μm Copper) partially covered with copper (645mm<sup>2</sup> area). The power dissipation  $P_{DSM}$  is based on Junction-to-Ambient thermal resistance value and the  $T_{J(MAX)}=175^\circ C$ . The value is only for reference, any application depends on the user's specific board design.
- (2) The power dissipation  $P_D$  is based on  $T_{J(MAX)}=175^\circ C$ , using junction-to-case thermal resistance, and is more useful in setting the upper dissipation limit for cases where additional heat sinking is used.
- (3) Repetitive rating, pulsed, duty cycle ~1%, keep initial  $T_J=25^\circ C$ , the maximum allowed junction temperature of 175°C.
- (4) The static characteristics are obtained using ~380μs pulse, duty cycle ~1%.
- (5) The parameter is not subject to production test - verified by design / characterization.

**TYPICAL CHARACTERISTICS**

Ta=25°C, unless otherwise noted.

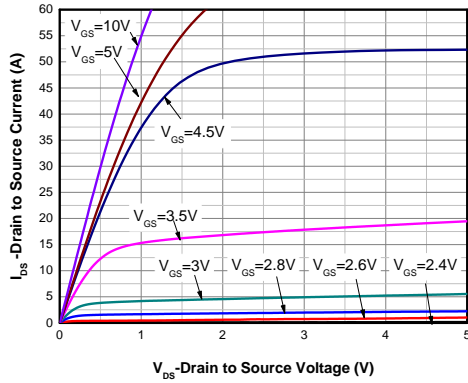

**Output Characteristics** (4)

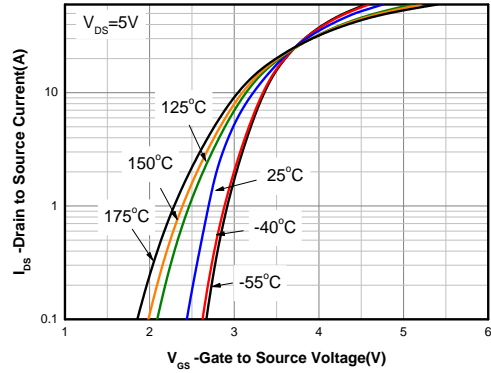

**Transfer Characteristics** (4)

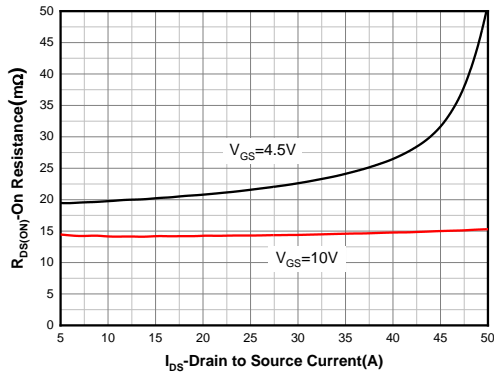

**On-Resistance vs. Drain Current** (4)

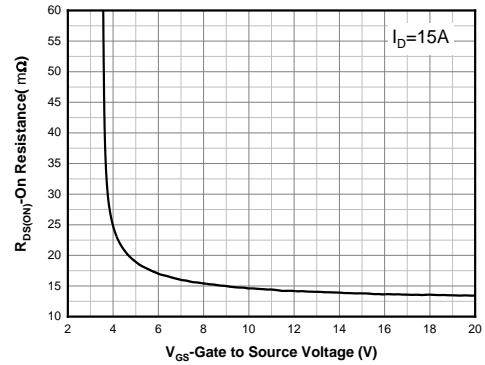

**On-Resistance vs. Gate-to-Source Voltage** (4)

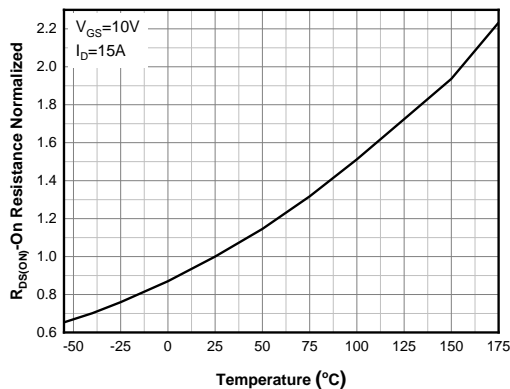

**On-Resistance vs. Junction Temperature** (4)

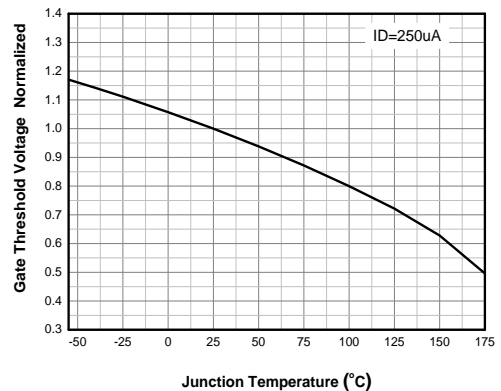

**Threshold Voltage vs. Temperature**

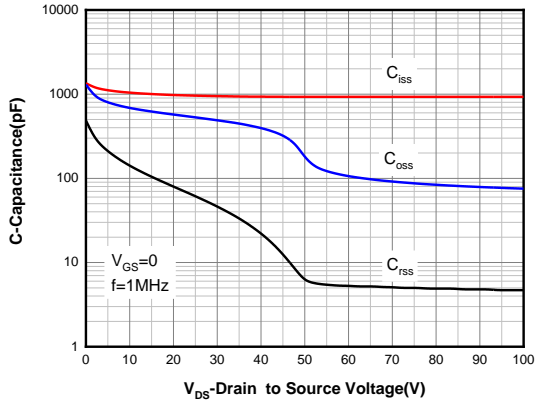
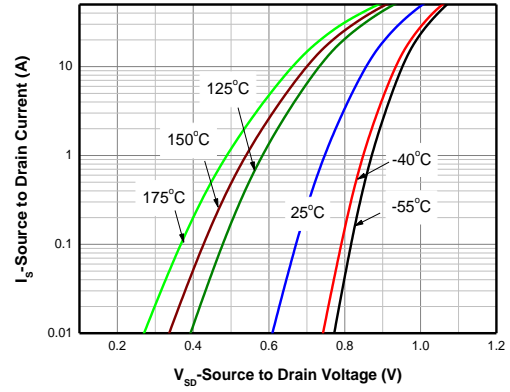
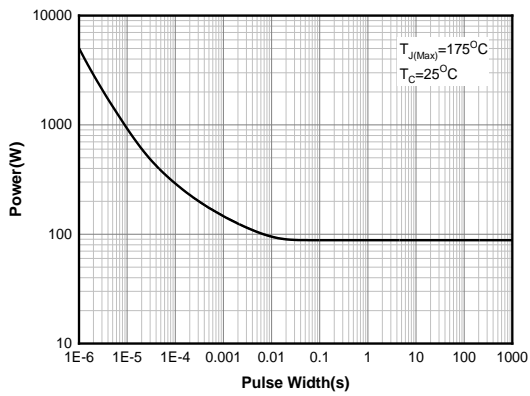
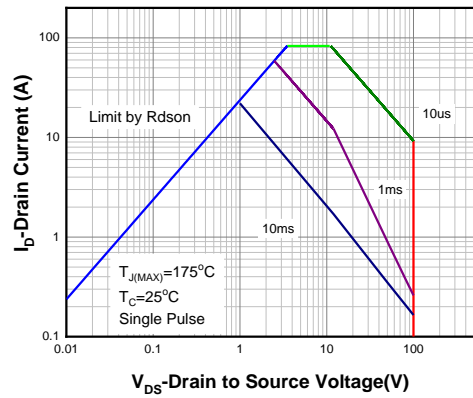
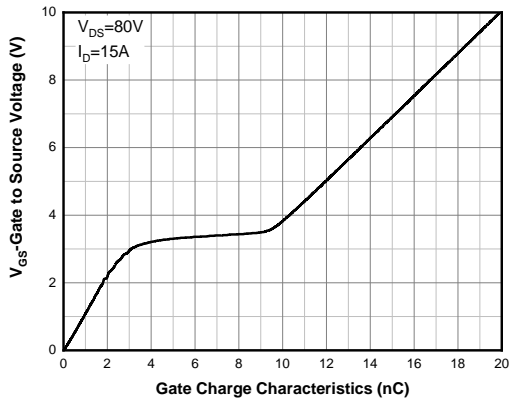
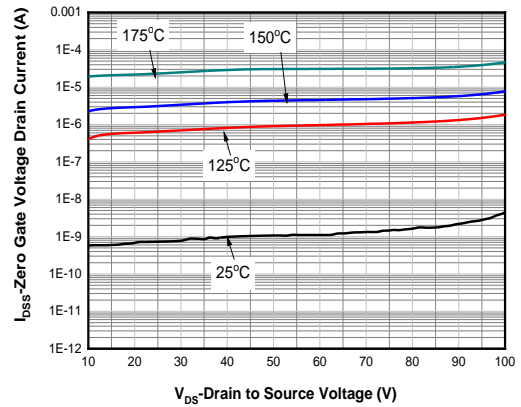
**Capacitance**

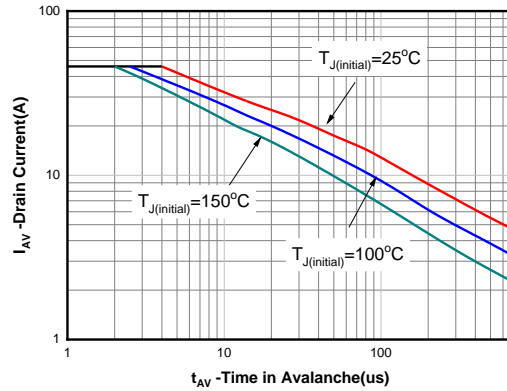
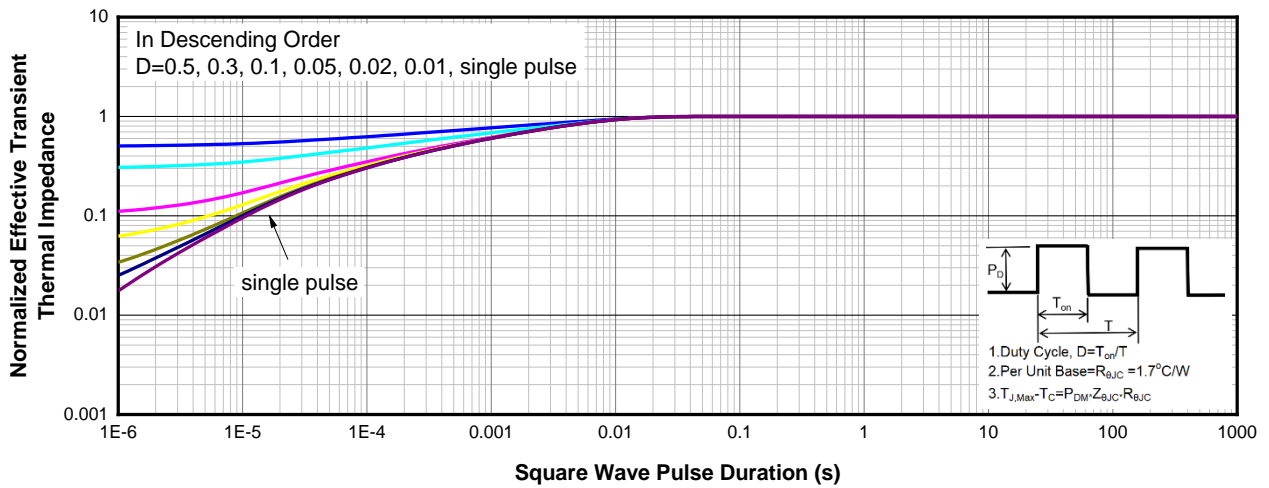
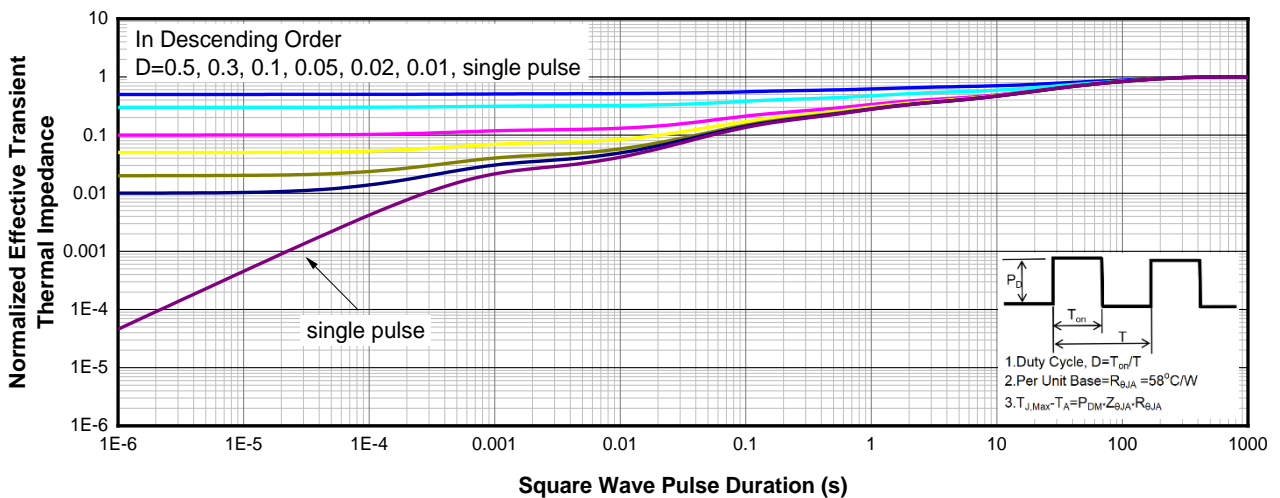
**Body Diode Forward Voltage <sup>(4)</sup>**

**Single Pulse power**

**Safe Operating Area**

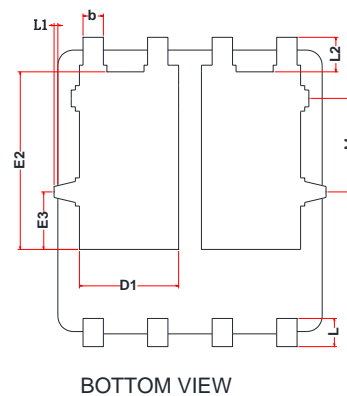
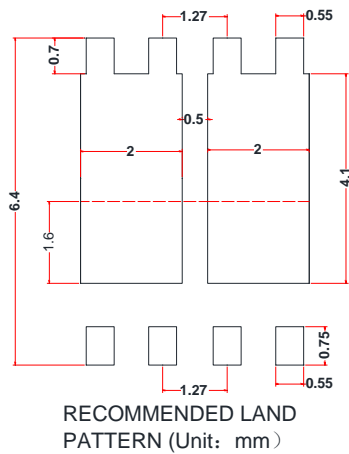
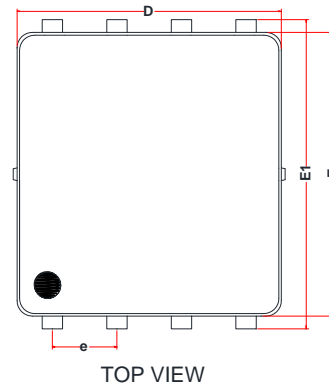
**Gate Charge Characteristics**

**Drain Current vs. Drain Voltage**



**Avalanche characteristics**

**Transient Thermal Response (Junction-to-Case)**

**Transient Thermal Response (Junction-to-Ambient)**

**PDFN5×6-8L DIMENSIONS**
**PACKAGE SIZE**

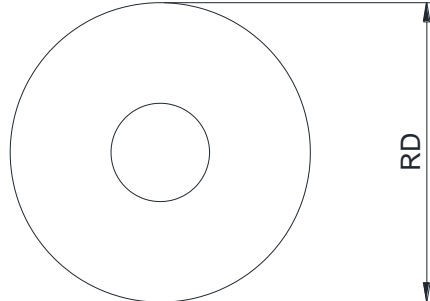
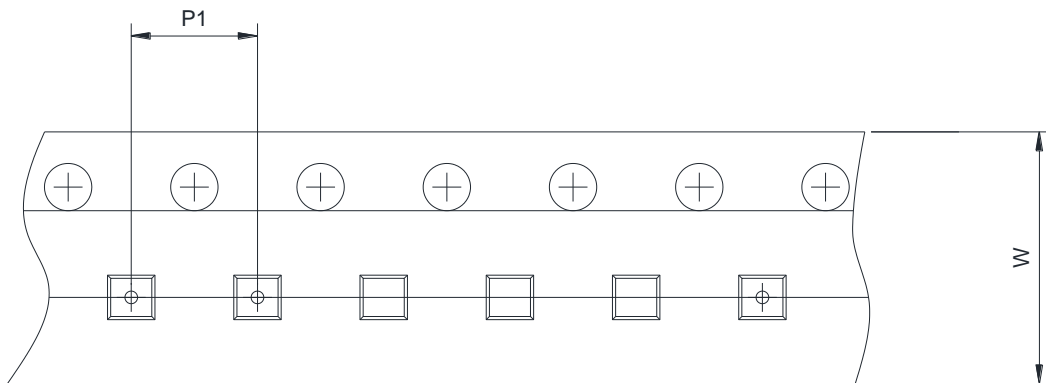
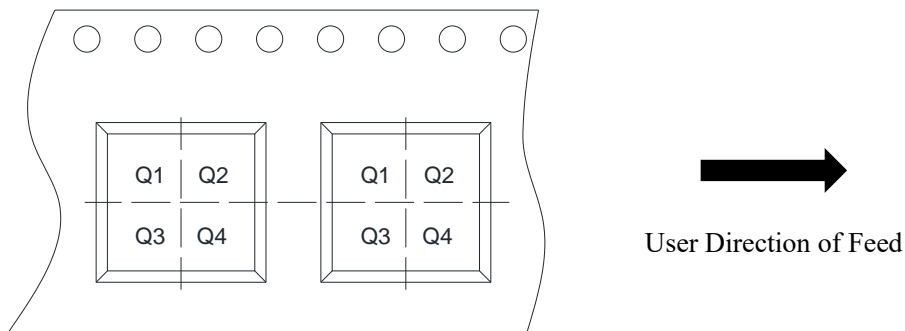
Symbol	Min.	Typ.	Max.
A	0.85	0.95	1.00
A1	0.00	---	0.05
A3	---	0.2 Ref	---
b	0.30	0.40	0.50
D	5.10	5.20	5.30
E	5.45	5.55	5.65
e	1.27 BSC		
D1	1.85	1.95	2.05
E1	5.95	6.05	6.15
E2	3.375	3.475	3.575
E3	1.025	1.125	1.225
L	0.45	0.55	0.65
L1	0	---	0.15
L2	0.675 Ref		
M	1.830 Ref		





**TAPE AND REEL INFORMATION**
**Reel Dimensions**

**Tape Dimensions**

**Quadrant Assignments For PIN1 Orientation In Tape**

RD	Reel Dimension	<input type="checkbox"/> 7inch	<input checked="" type="checkbox"/> 13inch
W	Overall width of the carrier tape	<input type="checkbox"/> 8mm	<input checked="" type="checkbox"/> 12mm <input type="checkbox"/> 16mm
P1	Pitch between successive cavity centers	<input type="checkbox"/> 2mm	<input type="checkbox"/> 4mm <input checked="" type="checkbox"/> 8mm
Pin1	Pin1 Quadrant	<input checked="" type="checkbox"/> Q1	<input type="checkbox"/> Q2 <input type="checkbox"/> Q3 <input type="checkbox"/> Q4

**ORDERING INFORMATION**

TYPE NUMBER	PACKAGE	PACKING
SND1019DNAQ-8/TR	PDFN5×6-8L	Tape and reel

PDFN5×6-8L is packed with 5000 pieces/disc in braided packaging.

**Important statement**

SIT reserves the right to change the above-mentioned information without prior notice.

**REVISION HISTORY**

Version number	Datasheet status	Revision date
V1.0	Initial version.	May 2024